

# Lock It Up



VP, Grey Hats UH Manoa

# Base Rules

- Lockpicking isn't illegal, breaking and entering is
- If it walks like a duck and looks like a duck
- Don't pick locks you rely on
- Don't pick locks you don't own



# Physical Security

- Physical security is important
- If you have physical access, you own it
- Be aware of weak points
- If they want it they'll find a way



# Types of Locks

- Pin and Tumbler
- Ratchet (handcuffs)
- Waffer (cars)
- Combination (padlock)
- Many more



# Pin and Tumbler

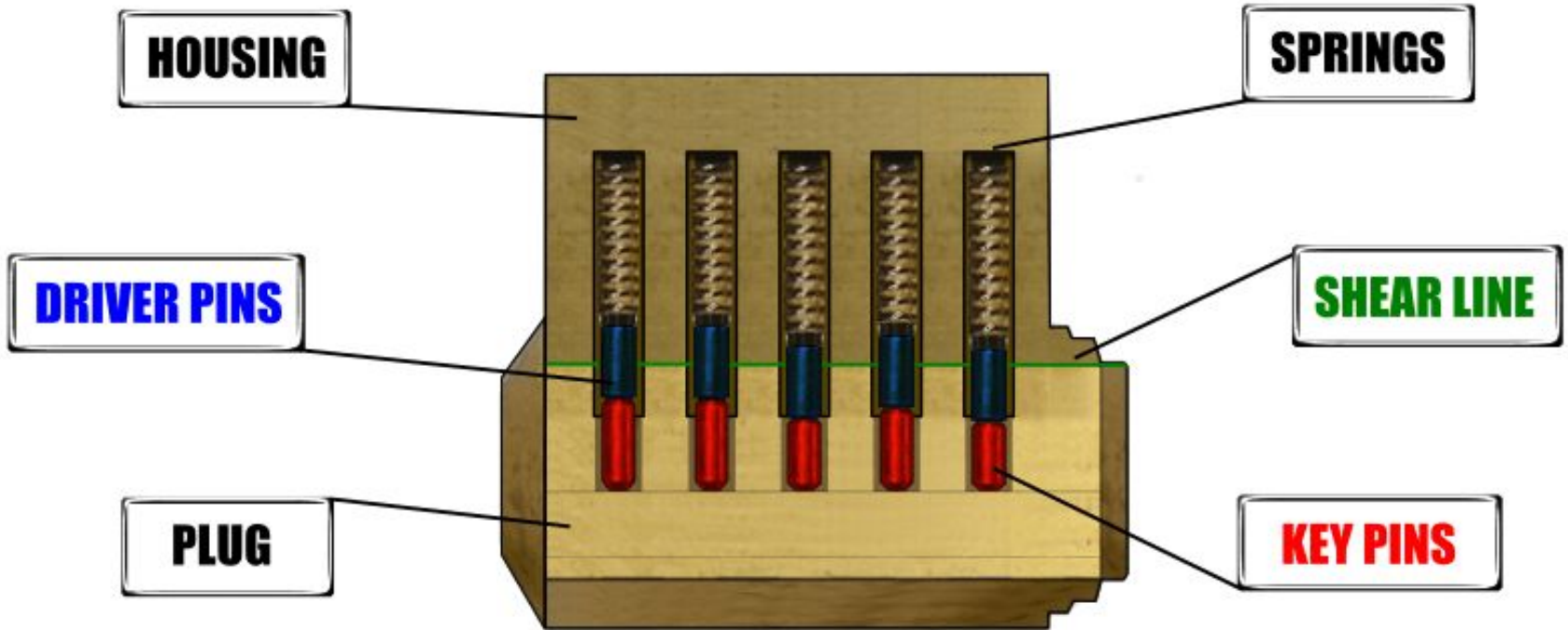

# Pin and Tumbler 2

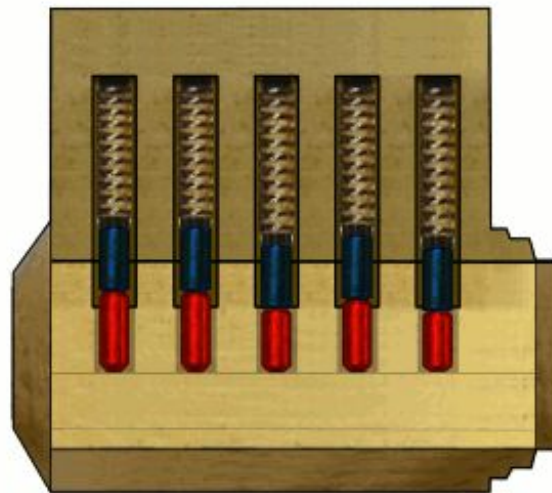
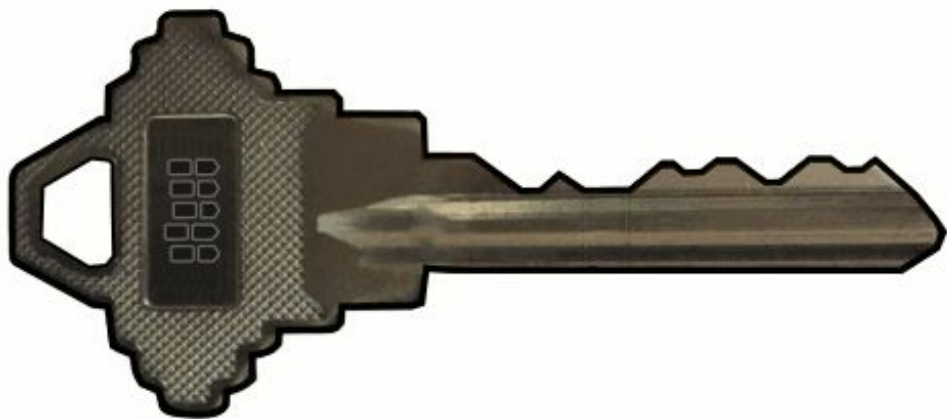

# Pin and Tumbler 3

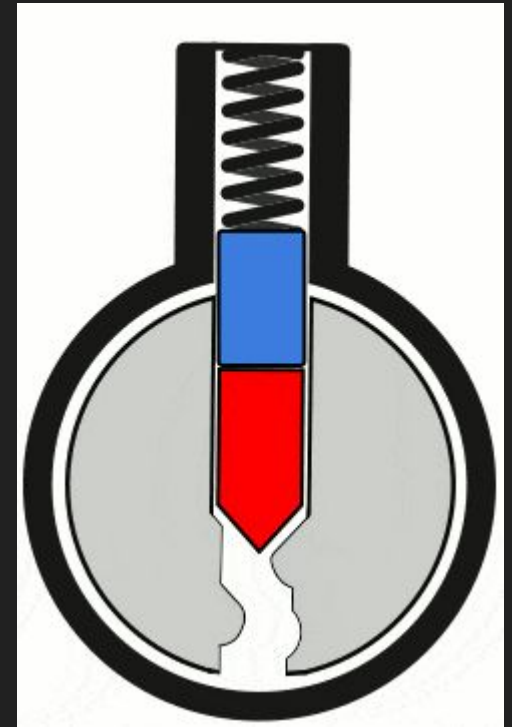
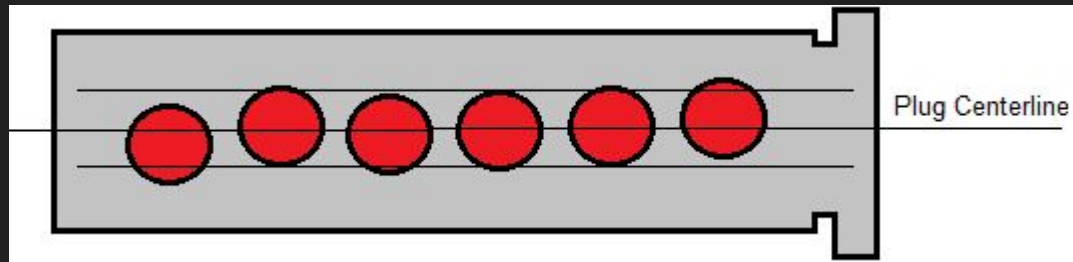
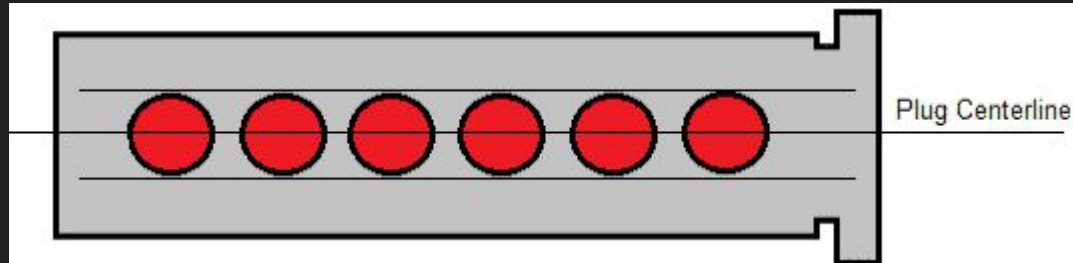

# Pin and Tumbler 4

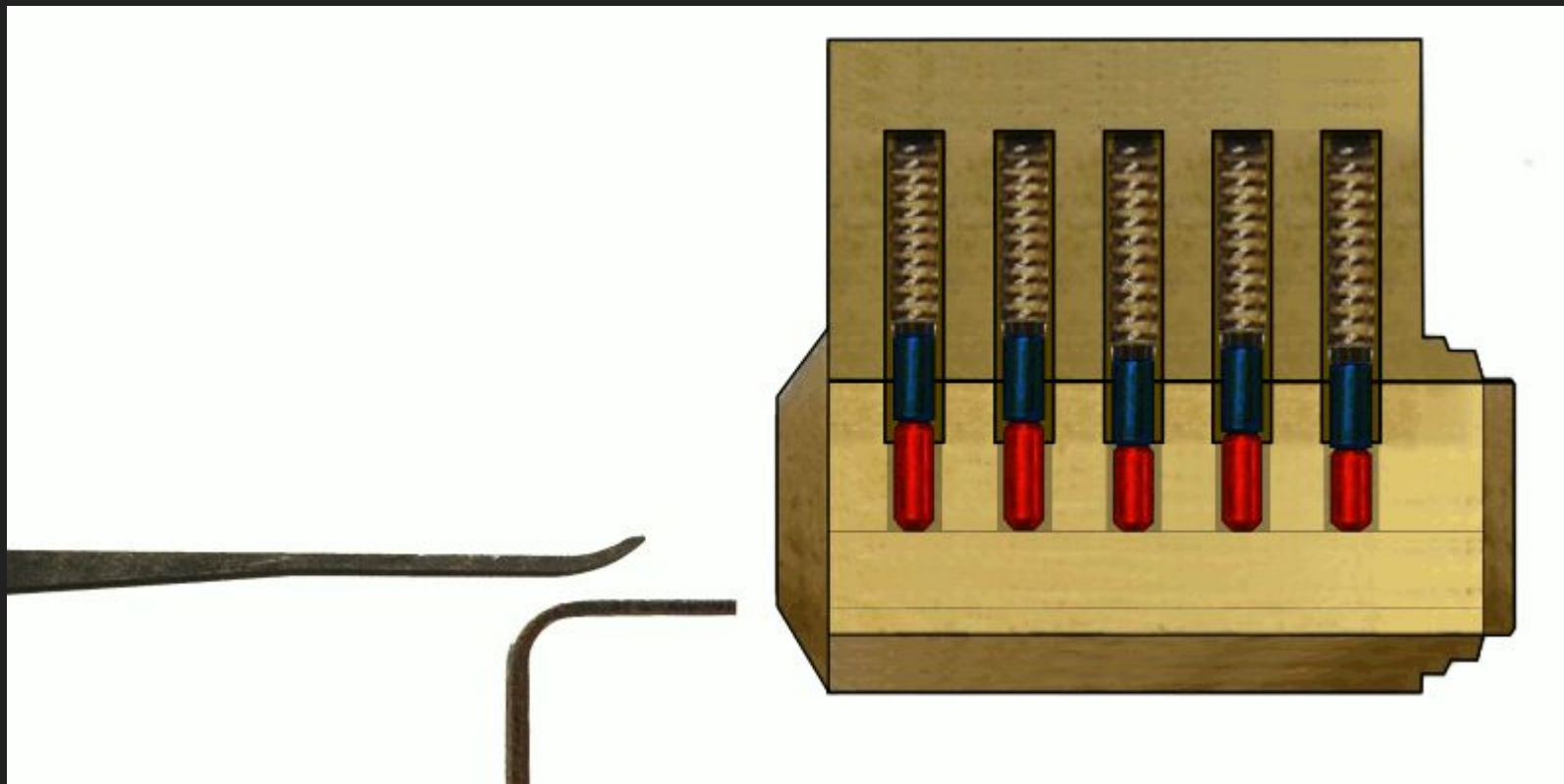



# Pin and Tumbler 5

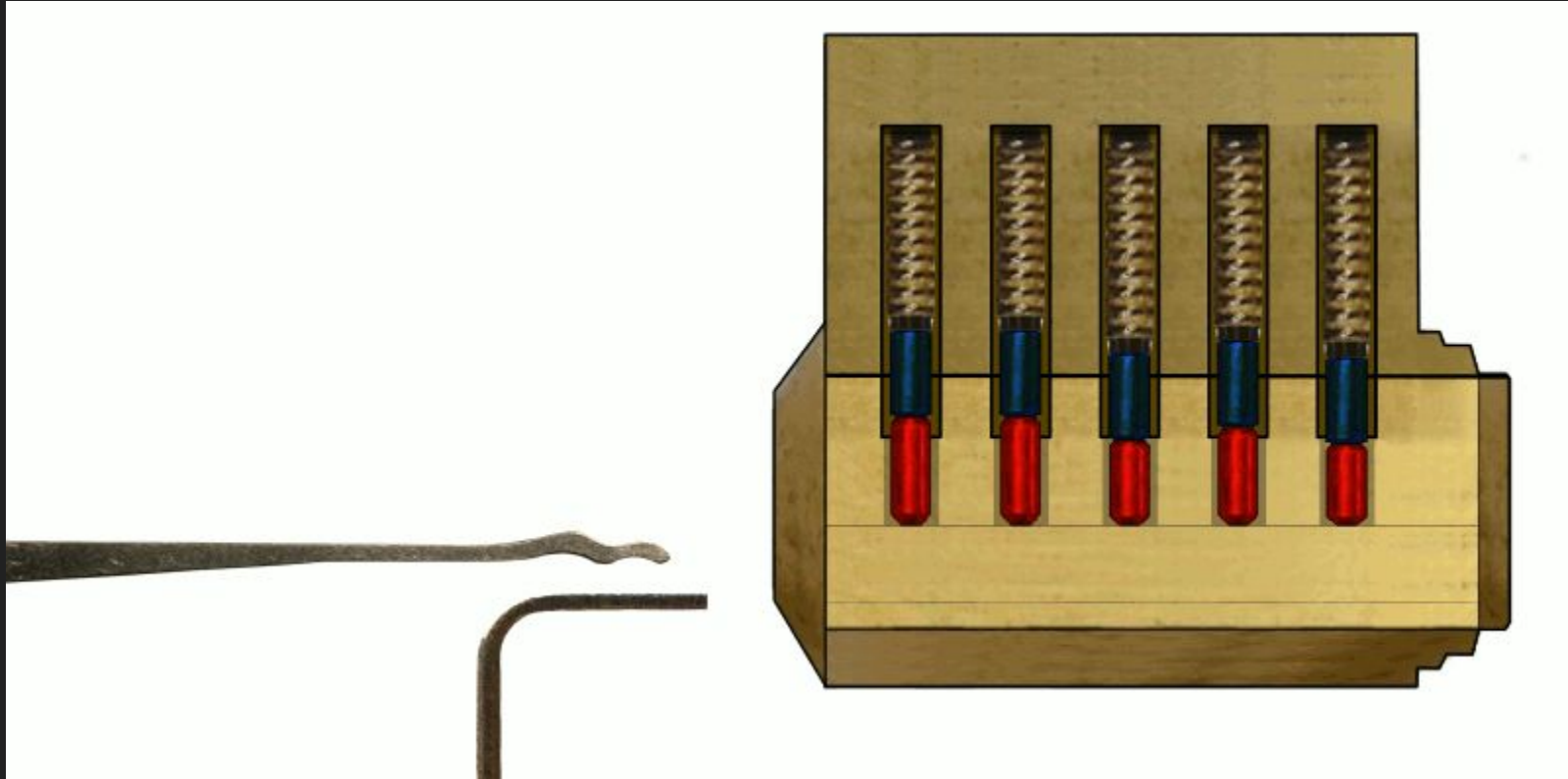

# Security Pins

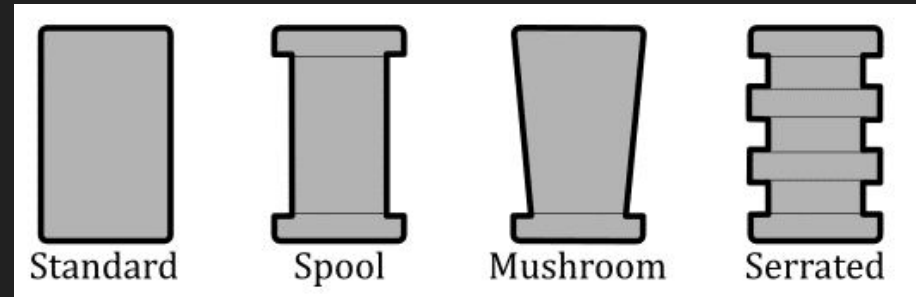
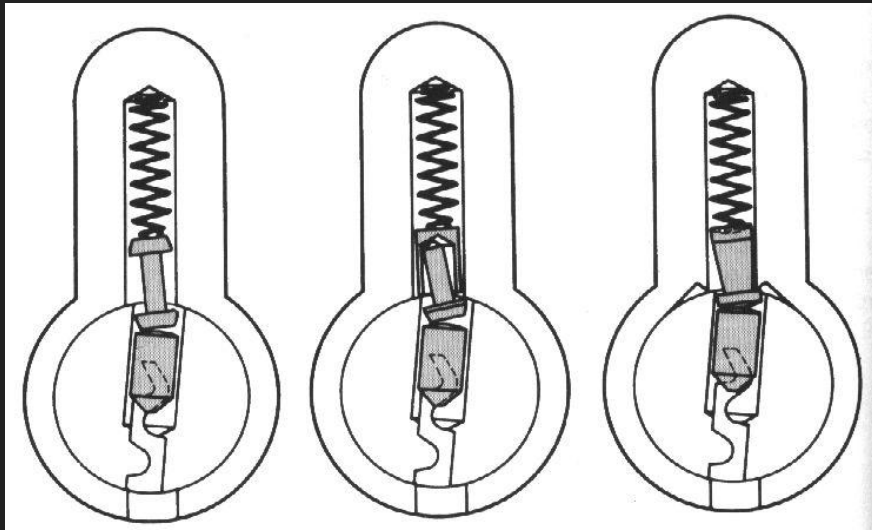

1337 sk1llz

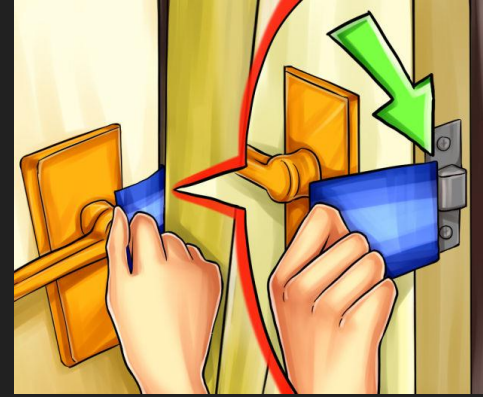
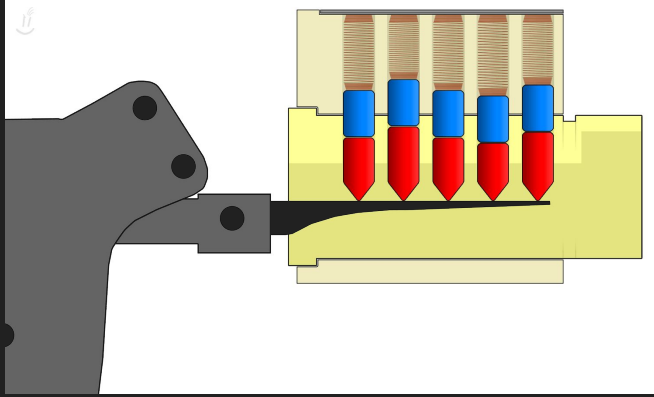

# Handcuffs

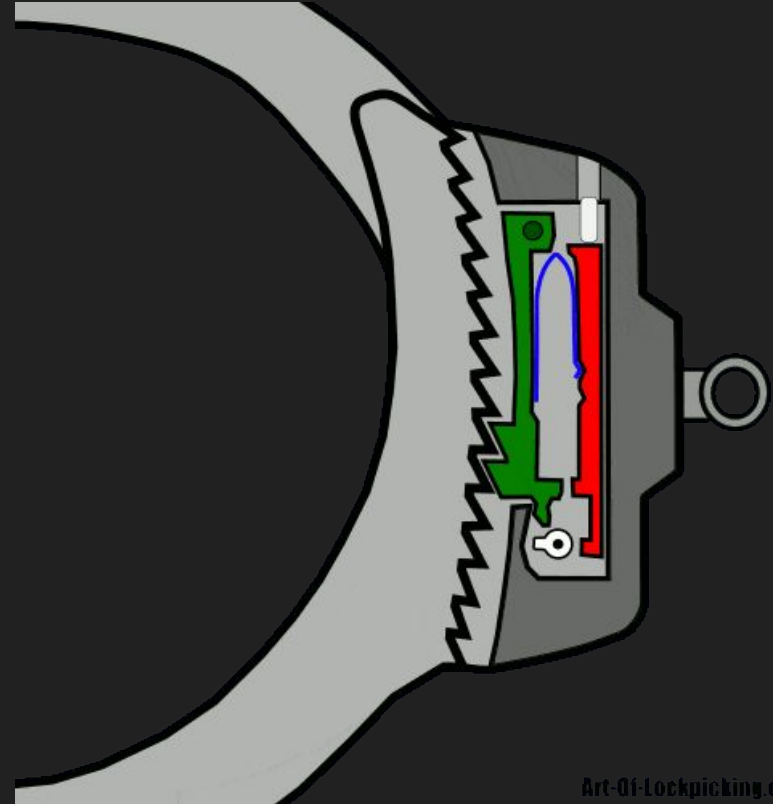
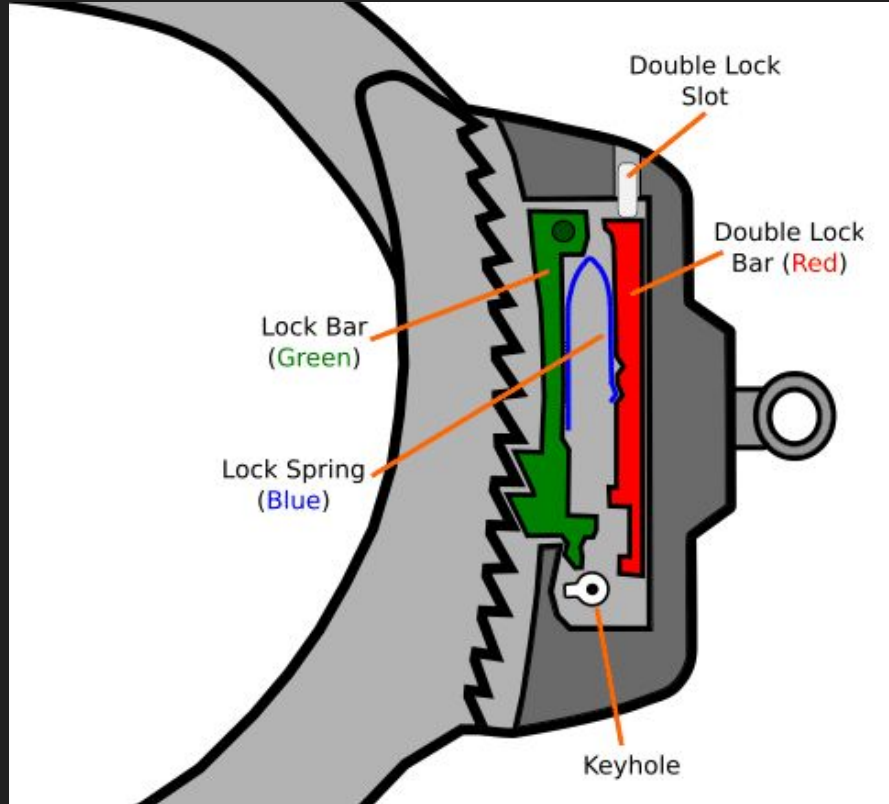

# Wafer

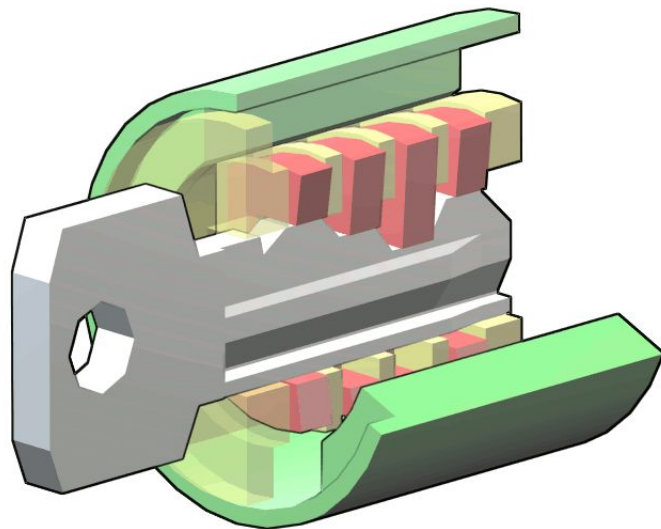
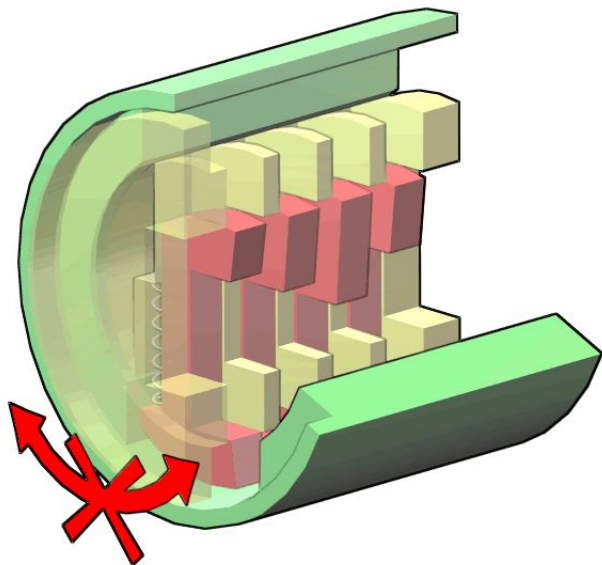

# Combination

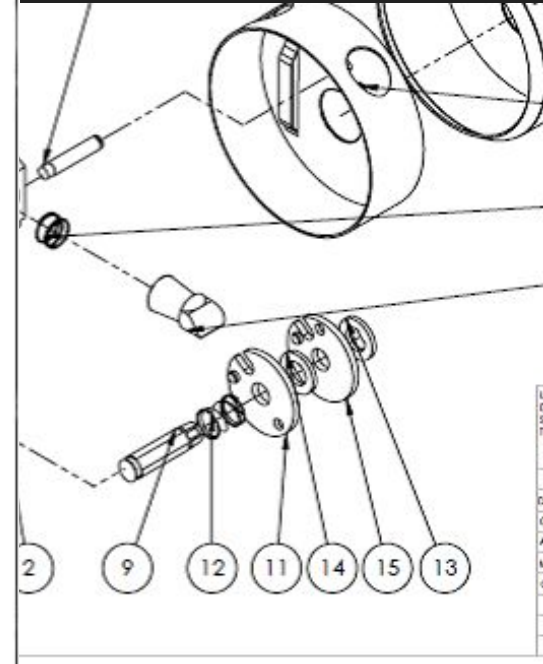
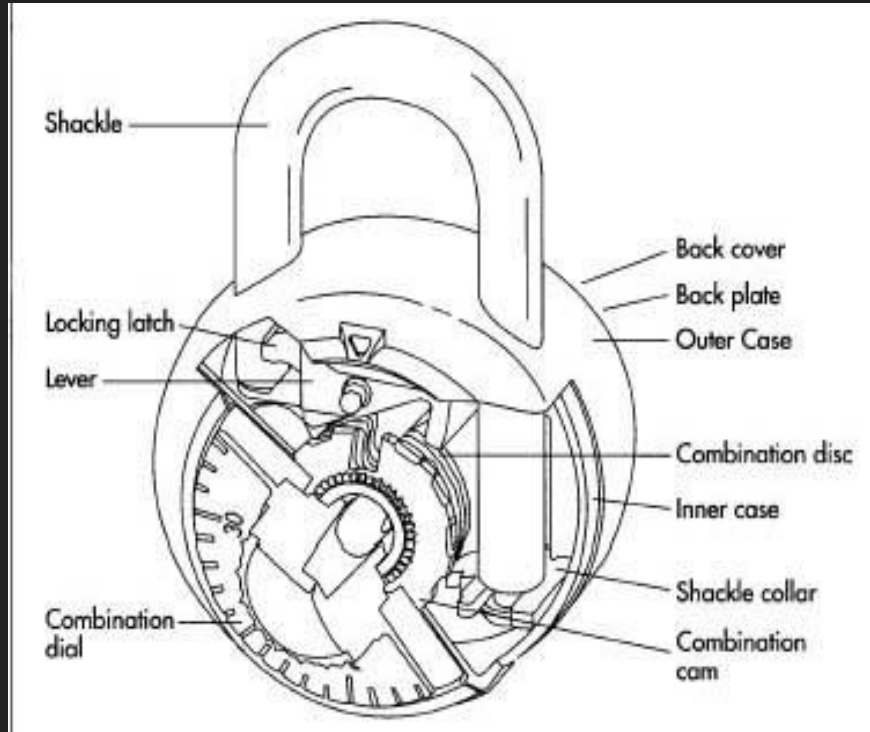

# Combination 2

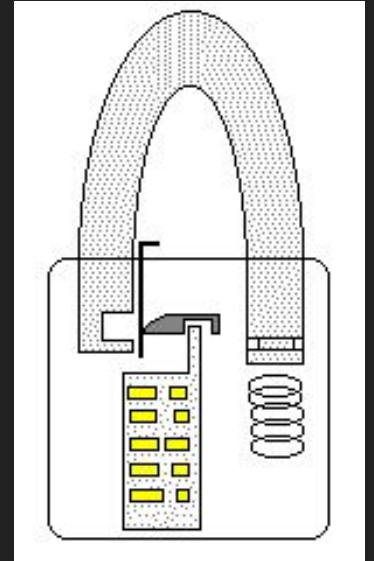
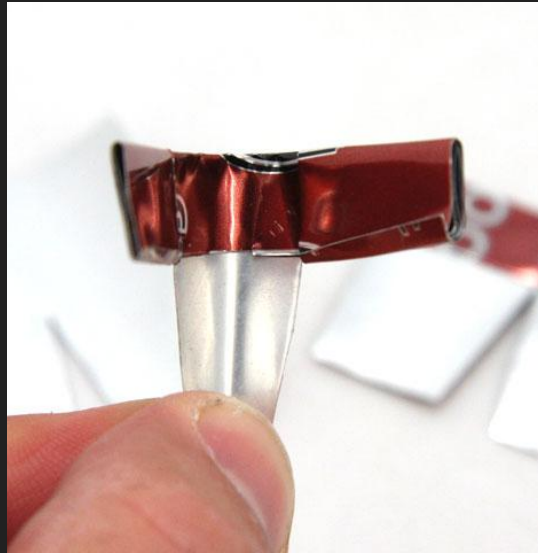
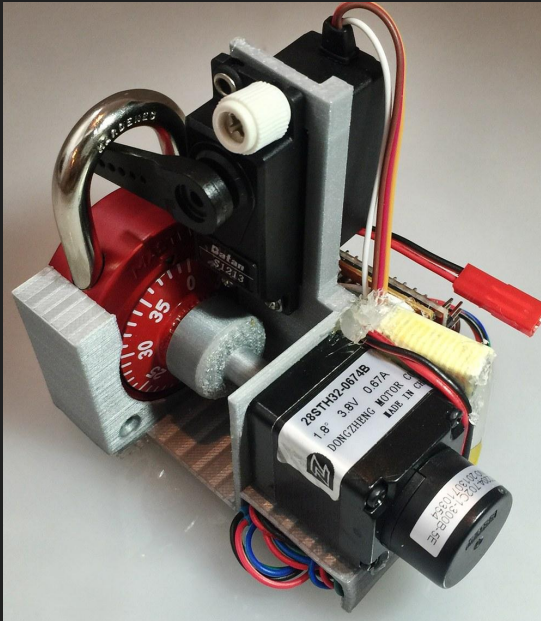

# How do I start?

- Don't overspend
- Cheap to start \$15-\$25
- Lockpicking, not stealing
- Able to use old or broken locks
- Don't pick what you don't own
- Don't pick what you rely on





# Questions?



# Sources

<https://art-of-lockpicking.com/how-to-pick-a-lock-guide/>

<https://null-byte.wonderhowto.com/how-to/crack-any-master-combination-lock-8-tricks-less-using-calculator-0161629/>